

SOLID STATE HOUR METERS & COUNTERS



700 SERIES

CURTIS



DESCRIPTION

The Curtis 700 Series are highly reliable solid state hour meters and counters that offer an unprecedented combination of patented technology, performance, reliability and value.

MODEL 700: 2-Wire Hour Meter, displays only when powered. Available in AC/DC.

MODEL 701: 3-Wire Hour Meter, has a provision or continuous display. Available in AC/DC and DC-only.

MODEL 703: Pulse Counter. Available in AC/DC and DC-only.

APPLICATIONS

A wide variety of industrial and commercial applications, including scheduled maintenance, warranty and leasing – for medical equipment, transport and industrial vehicles and other industrial equipment.

FEATURES

- All-8's LCD function test: each digit displays an eight for one second after power-up.
- Attractive 6-digit LCD 5mm or 7mm high digits (7mm with optional backlighting) are much easier to read than electro-mechanical meters, which have only 3mm high digits.
- Silent operation – no moving parts. Eliminates annoying gear and motor noise.
- Exceptional reliability due to nonvolatile memory (EEPROM) which retains data for 25+ years.
- Wide voltage ranges, for example, one unit can be powered from 75 to 270 VAC anywhere between 48 and 440 Hz – ideal for distribution and worldwide markets without having to stock multiple model types.
- Electrical reset (optional).
- Available in ten case styles – all fit in standard hour meter/counter cutouts.
- Multiple mountings available – Metal U-bracket, "U" clamp/stud (D, Q, R and S cases), flange mount with hardware (F, G, J cases), or mounting clip (G, L, Y, Z, cases).
- Backlit units allow external illumination control, i.e., on/off or dimmer (12VDC only).
- Flashing hourglass icon indicates when the hour meter is accumulating time.
- Memory will arm only when power has been applied for five seconds (with no loss of time or counts).
- Low power consumption.
- UL and CE recognized.

CURTIS INSTRUMENTS, INC.
200 KISCO AVENUE
MT. KISCO, NY 10549 USA
TEL (914) 666-2971
FAX (914) 666-2188

CURTIS INSTRUMENTS, (UK) LTD.
5 UPPER PRIORY STREET
NORTHAMPTON NN1 2PT, ENGLAND
TEL 44 (0) 1604-629755
FAX 44 (0) 1604-629876

**CURTIS INSTRUMENTS INDIA
PRIVATE LTD.**
1199, GHOLE ROAD
PUNE 411004, INDIA
TEL 91 (0) 20-5531288
FAX 91 (0) 20-5539192

700 SERIES

SPECIFICATIONS

Case Style	Bezel Shape	Lens Material	Case Material	IP Rating Front/Rear	Termination	UL ⁵ /CE	Suggested Panel Cutout mm
D	Rectangular	Acrylic	ABS	65/50	3/16" Spade	Yes	45.0 x 22.2
F	Hexagonal	Acrylic	ABS	65/65	1/4" Spade	Yes	36.8 x 24.1
G	Hexagonal	Acrylic	ABS	65/651	Packard (2 pin) 2	Yes	36.8 x 24.1
J	Hexagonal	Acrylic	ABS	65/651	Packard (4 pin) 3	Yes	36.8 x 24.1
L	Rectangular	Polycarbonate	Polycarbonate	65/40	Molex 4	Yes	36.8 x 24.1
Q	Round	Glass	Polycarbonate	65/506	1/4" Spade	Yes	ø52 (ø2-1/16)
R	Round	Glass	Polycarbonate	65/506	3/16" Spade	Yes	ø52 (ø2-1/16)
(5mm display)							
R	Round	Glass	Polycarbonate	65/50	1/4" Spade	Yes	ø52 (ø2-1/16)
(7mm display)							
S	Square	Glass	ABS	52/50	1/4" Spade	Yes	45.0 x 45.0
Y	Rectangular	Acrylic	ABS	65/651	Packard (4 pin) 3	Yes	36.8 x 24.1
Z	Rectangular	Acrylic	ABS	65/65	1/4" Spade	Yes	36.8 x 24.1

Display	6 digit LCD, 5 or 7mm high
Range & Resolution	Hour meters: 99,999.9 hours Counters: 999,999 counts
Accuracy	Hour meters: 0.1% Counters: ±1 count
Humidity	95%, non-condensing at 38°C
Operating Temperature	-40°C to +85°C
Storage Temperature	-50°C to +85°C
Mechanical Shock	SAE J 1378, 55g
Mechanical Vibration	SAE J 1378, 20g
Operating Frequency (AC powered units)	48 to 440 Hz
Memory	Main power must be applied for 5 seconds to arm memory (with no loss of time/counts). EEPROM, data retained for 25+ years without power.
Current Consumption (Power Terminals)	0.5mA max. @ 5VDC (0512D models) 0.8mA max. @ 12VDC (1248D models) 1.0mA max. @ 120VAC 2.0mA max. @ 230VAC
Input Signal (DC-only)	Counters (703 only): 500 Hz. max., 50% duty cycle (1ms low, min., between consecutive highs)
Input Signal (AC/DC)	Hour meters (701 only): Power must be applied for 0.5s, min., to accumulate time. Counters (703 only): 1 Hz. max., 50% duty cycle (500ms low, min., between consecutive highs)
Reset	5ms min. at operating voltage. Main power must be applied for a minimum of 250ms prior to reset signal.

NOTES:

1. Mating connector must be installed.
2. Equivalent to Delphi-Packard connector P/N 12162000 2-pin.
3. Equivalent to Delphi-Packard connector P/N 15336035 4-pin.
4. Equivalent to Molex connector P/N 43045-0412.
5. UL files AU1841 and E45175.
6. R(5mm) and Q housings also available in a 65/65 version (see model encodement).

700 SERIES

MODEL ENCODING

700 MODEL	R Case Style	R Resetability	001 Additional Feature	O Logo*	0512D0612A Operating Voltage
700 = (2-wire hour meter, AC/DC only)	D F G ¹	R = Electrically	001 = 5mm, non-backlit display (Standard)	O = Curtis Logo N = No Logo	0512D = 5-12VDC nom., 4.75-15VDC abs.
701 = (3-wire hour meter, AC/DC or DC-only)	J L ² Q		091 = Epoxy filled unit (moisture resistant, Q, R (5mm), cases only)		1248D = 12-48VDC nom., 9-60VDC abs.
703 = (3-wire counter, AC/DC or DC-only)	R S Y Z		601 = 7mm, backlit display (R or S case only)		48150D = 48-150VDC nom., 36-185VDC abs.
			701 = 7mm, non-backlit display (R or S case only)		0512D0612A = 5-12VDC nom., 4.75-15VDC abs. 6-12VAC nom., 5-15VAC abs.
					1248D2060A = 12-48VDC nom., 9-60VDC abs. 20-60VAC nom., 15-75VAC abs.
					48150D100230A = 48-150VDC nom., 36-185VDC abs. 100-230VAC nom., 75-270VAC abs.

1. Only model offered: 700GN001N1248D2060A
2. Only models offered: 700LN001N1248D2060A, 700LN001N48150D100230A and 701LN001N1248D

* Custom logos are available
Backlight available on 7mm R or S cases only.

WIRING GUIDE

Case Style	Pin 1	Pin 2	Pin 3	Pin 4	Pin 5	Pin 6
D, F, J, Q, R (5mm), Y & Z	V+	V-	I	R	N/A	N/A
G	V+	V-	N/A	N/A	N/A	N/A
L	V+	V-	I	N/A	N/A	N/A
R (7mm), S	V+	V-	R	I	L	N/A

- V+ Operating voltage
- V- Common (ground)
- I Enable (Optional, use operating voltage to power this pin to record elapsed time (701) or increment count (703).)
- R Reset (Optional, supply with operating voltage when unit is to be reset to 0.)
- L Lighting control (Optional, 9-15VDC absolute only, regardless of operating voltage.)
- NC No connection

DIMENSIONS IN MM

Case Style D

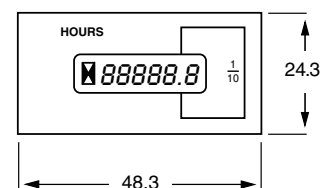
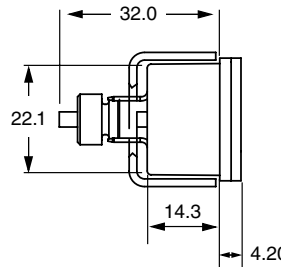
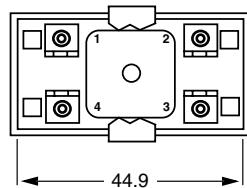

700 SERIES

DIMENSIONS IN MM

Case Style F

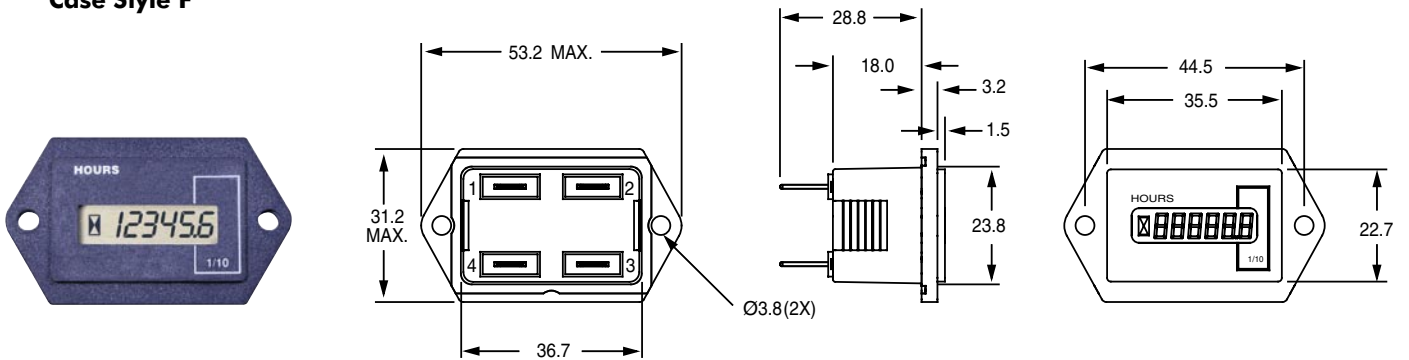

Case Style G

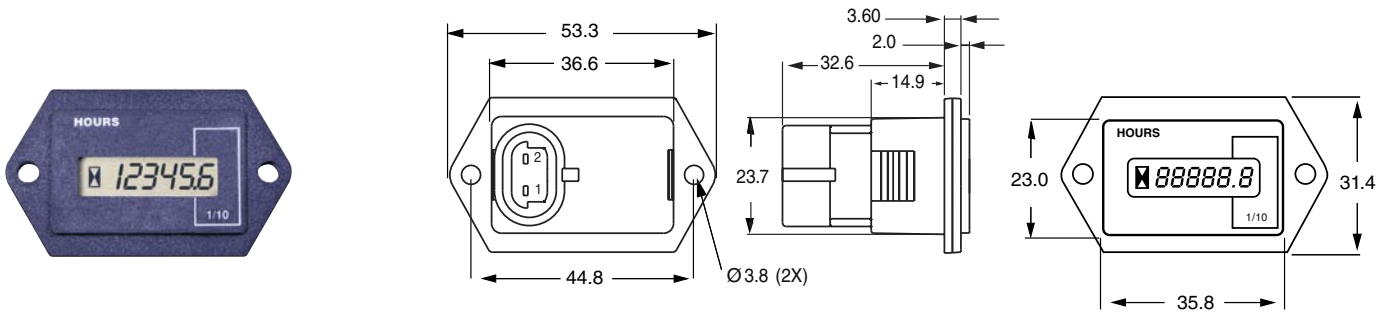

Case Style J

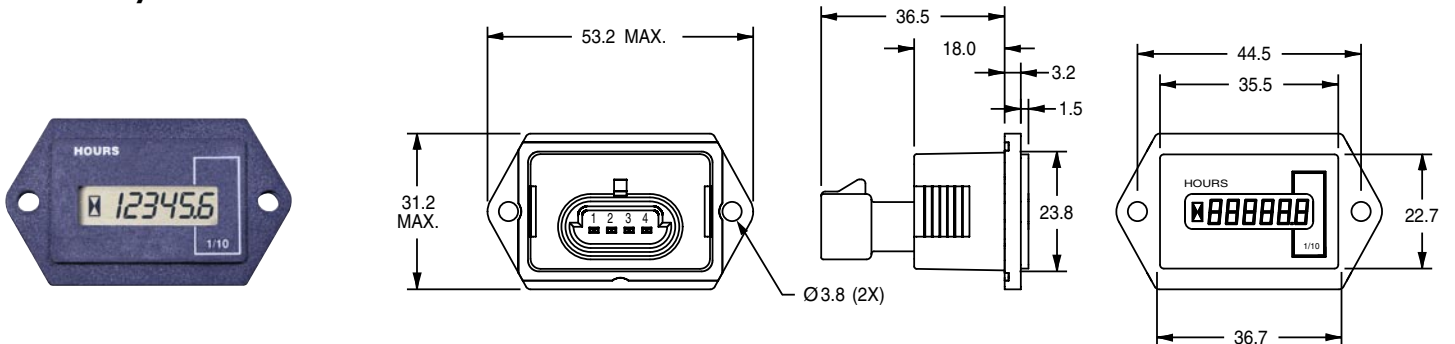

700 SERIES

DIMENSIONS IN MM

Case Style L

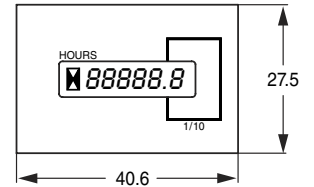
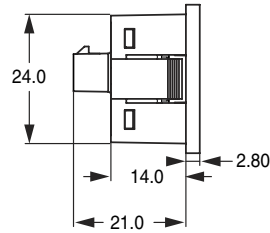
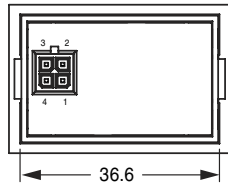

Case Style Y

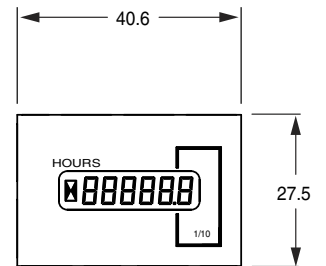
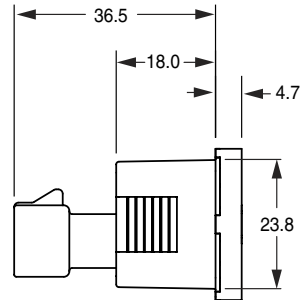
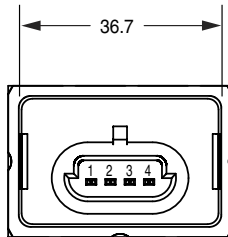

Case Style Z

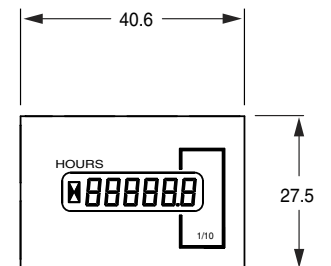
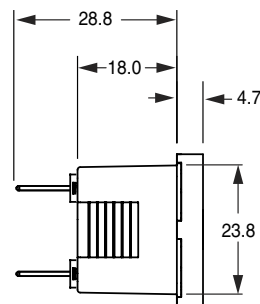
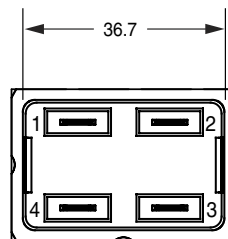

700 SERIES

DIMENSIONS IN MM

Case Style Q

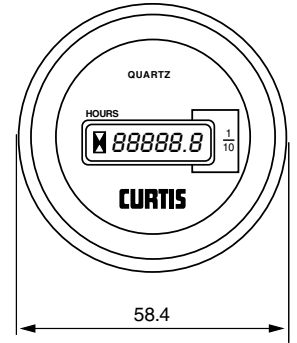
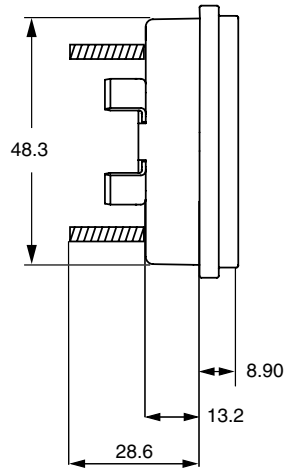
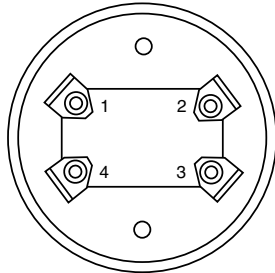

Case Style R (5mm)

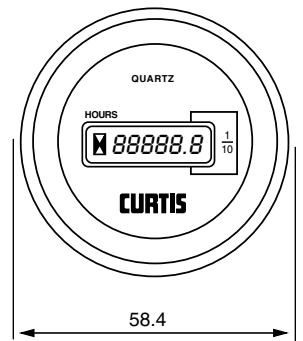
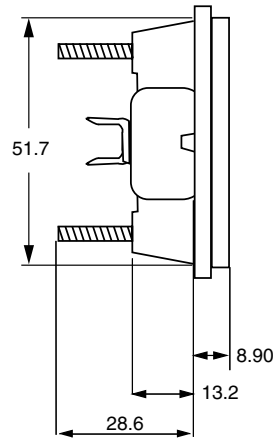
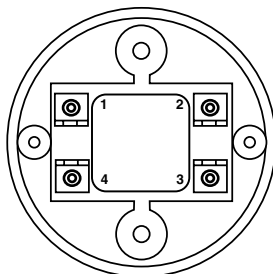

Case Style R (7mm)

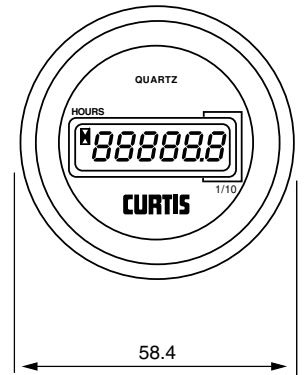
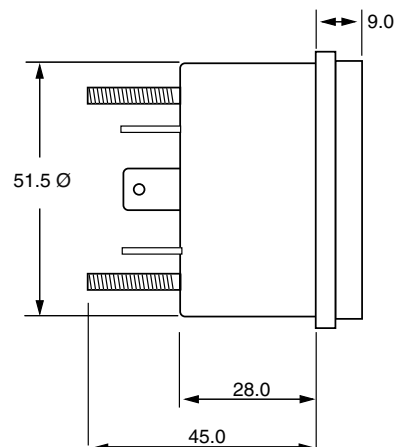
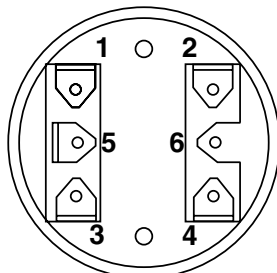

700 SERIES

DIMENSIONS IN MM

Case Style S

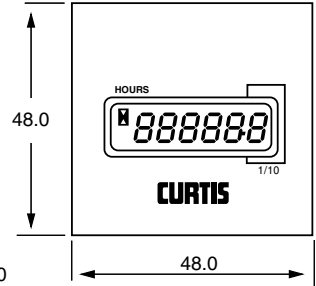
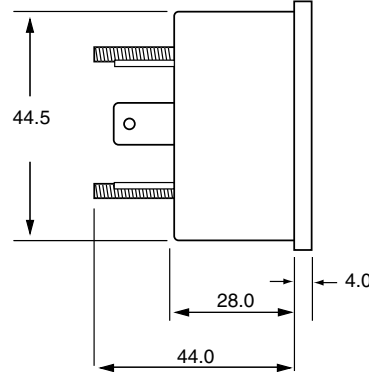
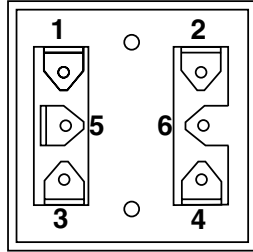
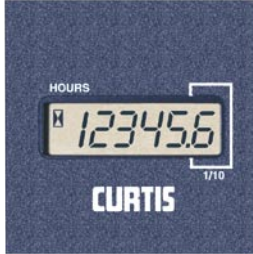

700 SERIES HARDWARE

Case Style	F		G, J		D, Q, R, S		Y		Z	
Shipping Style	Carton	Bulk	Carton	Bulk	Carton	Bulk	Carton	Bulk	Carton	Bulk
Steel Slot Screws	2	2	2	2						
Steel Hex Nuts		2		2		2				
Plastic Thumb Nuts	2		2		2					
Lock Washers	2	2	2	2	2	2				
Faston Terminals	4				4				4	
Plastic Bracket							1	1	1	1
Metal U Bracket					1	1				

Note: L case does not require hardware.

ACCESSORIES

Curtis P/N	Description
17607303	Plastic mounting bracket for F, G, J, Y & Z models
17607800	100 mounting clips for F, G, J, Y & Z case
12237003	Dash Mounting Bracket, L-shape
13210001	Meter Guard (1 box of 10 meter guards) R & Q models
13515801	3-Hole Mounting Kit, for Ø2.53" mounting holes
13515905	3-Hole Mounting Kit, for Ø2.44" mounting holes
15336002	Gasket for F, G and J cases
15336003	Gasket for R (5mm) case
15336005	Gasket for Q and R (7mm) cases

WARRANTY: Two-year replacement warranty.



is a registered trademark of Curtis Instruments, Inc.
Specifications subject to change without notice